

LADDOMATIC® M120

Manual and installation instructions

ErP
READY
2015

APPLIES TO
EUROPEAN
DIRECTIVE
FOR ENERGY
RELATED
PRODUCTS

Function

Thermal layering

Thanks to its design and control features, the Laddomatic M120 means optimal thermal layering in storage tanks, with a low and even charging flow. This layering is beneficial as it increases storage capacity.

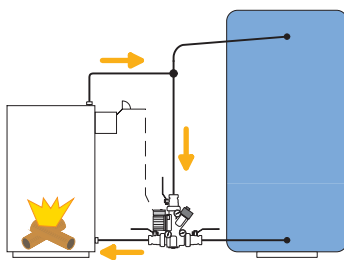
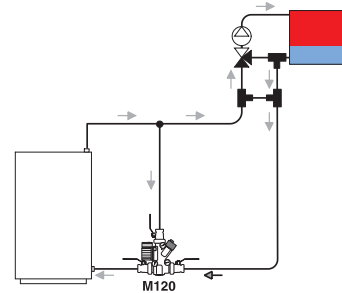
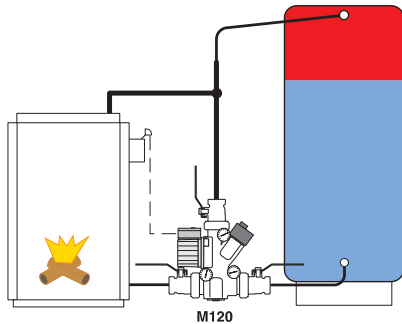

Start up phase

Laddomatic M120 enables the boiler to attain working temperature in a very short space of time. This improves boiler efficiency.

During Start up, the water is only circulating internally in the boiler.

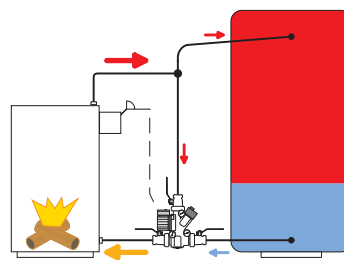

Operating phase

Laddomatic M120 charges the storage tank by means of a slow flow of hot water to obtain optimal thermal layering.

During Operating, some cold water from the storage tank is mixed with hot water from the boiler.

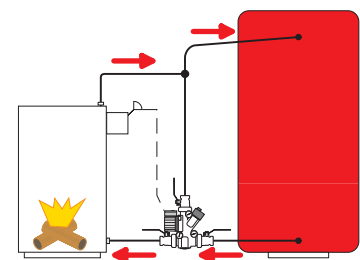

Final phase

The storage tank becomes fully charged and all flow from the boiler goes directly to the storage tank.

After the pump stops, the check valve in the Laddomatic allows residue heat from the boiler to be transferred to the storage tank by self-circulation.



Technical data

Pump:	Wilo Yonos Para 7,5
Flow characteristics:	Linear / Kvs ~16
Connections:	R32
Max output:	120 kW
Actuator choice:	Thermomatic TVM, actuator only (for external control) Thermomatic CC, Constant temp. controller

Installation of Laddomatic M120

Dimensioning

Generous pipe dimensions and short lengths guarantee operating reliability, even when boiler output is high. This also improves self-circulation* in the event of power failure.

Recommended pipe dimensions for a maximum boiler-to-tank distance of 2 m. Total length boiler-tank-boiler would then be 2 + 2 m + 6 bends. 1 bend is equivalent to 1 m pipe length.

Boiler with max output** up to:

50 kW min. Cu28 alt. R25
80 kW min. Cu35 alt. R32
100 kW min. Cu42 alt. R40
120 kW min. Cu54 alt. R50

Flow:

3 – 4 m³/h. See flow diagram below.

The dimensions must be increased for longer distances.

The maximum recommended distance between boiler and tank is 6 m. Total length would then be 6 + 6 m + 6 bends. Longer distance is possible, but pump flow and self-circulation capacity will decrease.

If there are special requirements for self-circulation, the pipes must be dimensioned accordingly.

*Maximum distance and self-circulation

Remember that flow capacity will decrease, both when it comes to pump flow as well as self-circulation.

If there are special requirements for self-circulation, the pipes must be dimensioned accordingly.

** Boiler output:

There is a difference between the nominal output and the maximum output of a boiler. The maximum output can be as much as 30-50% higher than the boiler's nominal output.

Example: If the boiler's nominal output is 40 kW, the max output can reach up to 60 kW.

This is very important to include in the calculation when dimensioning the system.

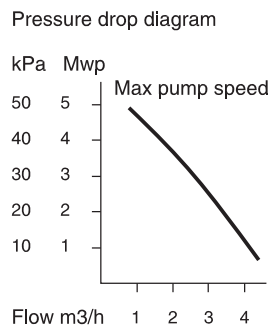
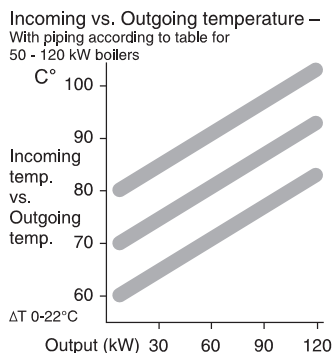
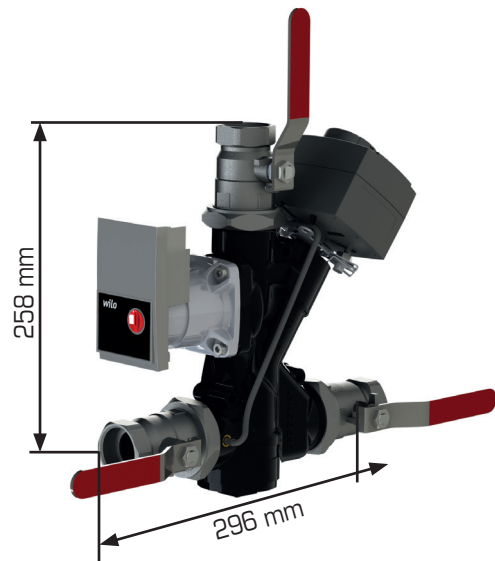

Connection

Laddomatic M120 must always be connected in the upright position as shown in the diagrams.

Place Laddomatic M120 as low as possible (to avoid keeping the unit warm when not firing), normally at the level of the boiler's bottom inlet.

Pipe-runs must be as short as possible and have the minimum number of bends. Make sure that all air pockets are eliminated.

The diameter of the pipe from the top of the boiler to the T-pipe and down to the Laddomatic M120 is recommended to be as large as possible. This gives low water velocity, and allows air released in the boiler to separate out in the expansion chamber or the vent.

Expansion vessel

The expansion vessel must be sufficiently large, at least 5–10% of the total volume for an open system.

If a pressure vessel is installed, this must be at least 10–20% of the total volume. Each installation must be specially dimensioned in accordance with the manufacturer's instructions.

Check that the operating pressure, when the system is cold, is never lower than the height difference between the pressure gauge and the highest radiator + 2 metre water pillar (mwp, 1 m = 0,1 bar).

Radiator system

To make the maximum use of the storage tank, it is recommended that the radiator system is fitted with:

1. Automatic mixing valve control like Thermomatic EC Home.
2. Thermostatic valves with integrated pressure reduction devices, which are set to suit the radiator size.
3. Use of pressure controlled circulation pump for the heating system.

These measures are intended to reduce the flow and so reduce the return temperature, without raising the delivery temperature. The lower the return temperature, the longer the heat in the tank lasts.

Starting the pump

See image.

The pump can be started by a flue thermostat (1). If extra safety is required, a water thermostat (2) can be connected in parallel.

Pump start alternative

On, for example, pellet burners the pump can be started and stopped at the same time as the burner.

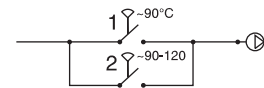
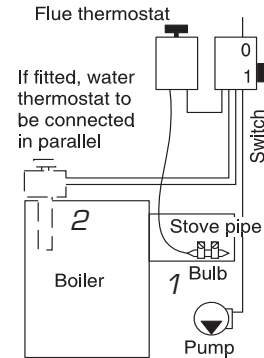

Connection suggestions

Connecting to 1 tank

1. The pipe-runs shown on the diagram are optimised to minimise air-related operating interruptions.
2. The hot water pipe to the by-pass valve can be connected in two ways.
 - A. Approx 30 cm from the top of the tank to prioritise domestic hot water.
 - B. On the charge line connection to the tank to prioritise heating. The connection is directed downwards to prevent air rising to the radiators.

Laddomatic M120 can easily be reversed for right-hand mounting. Just move the thermometers to the other side.

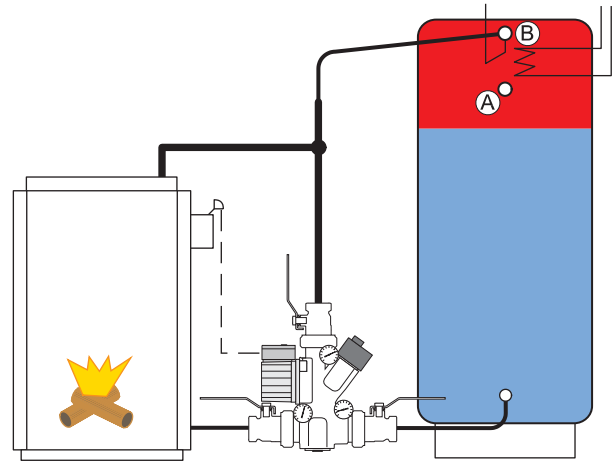
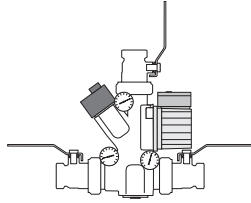

Connecting 2 tanks

The tanks must be located up against each other, and as close as possible to the boiler. The pipe-runs from the bottom of the tanks are always laid close to the floor.

It is important that the flow to the tanks during charging and discharging is distributed equally. If the system is connected incorrectly, then charging will be cut off when tank 1 is full of hot water which will reach the boiler before the other tanks are completely filled. Tank 2 will be virtually unused.

If the system is connected incorrectly, the warm water and the heat will run out earlier than estimated after the burner has stopped, since tank 1 will cool down more quickly than the other.

If these requirements cannot be met, there are other connection options.

Equal pipe lengths

To achieve equal resistance, it is essential to use approximately the same pipe-lengths to the tanks, this is achieved by:

1. Connecting the charging circuit diagonally, A–A.
2. Connecting the radiator circuit diagonally, B–B.

In addition, the dimension of the pipes between the tanks must be large enough to facilitate self-circulation between the tanks. It is an advantage if the tanks are connected together in the centre, to further distribute the heat.

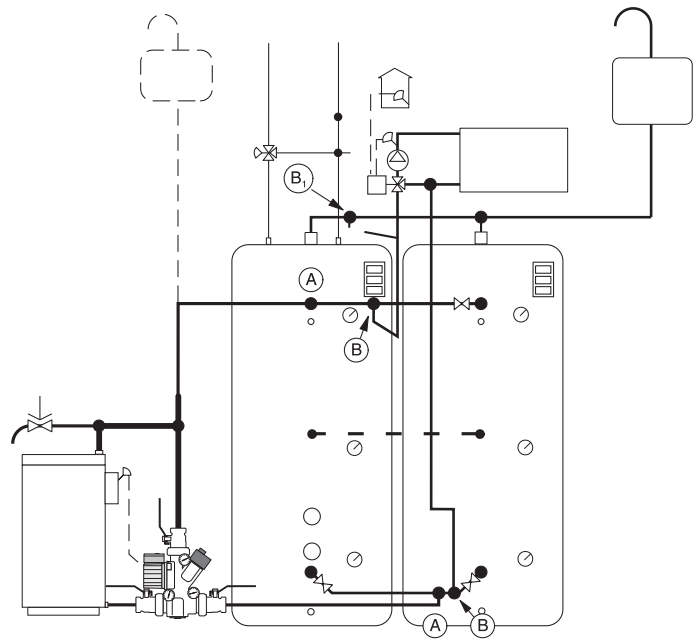

Connecting the by-pass valve

The hot water port is connected at B, which prioritises hot water, or at B₁, which prioritises heating.

Electrical immersion heater operation

When operating solely on the electrical immersion heater, it is an advantage only to heat the first tank to prevent heat loss. Shut off the other tank using the valve at the bottom of the tank.

Installation with open expansion vessel

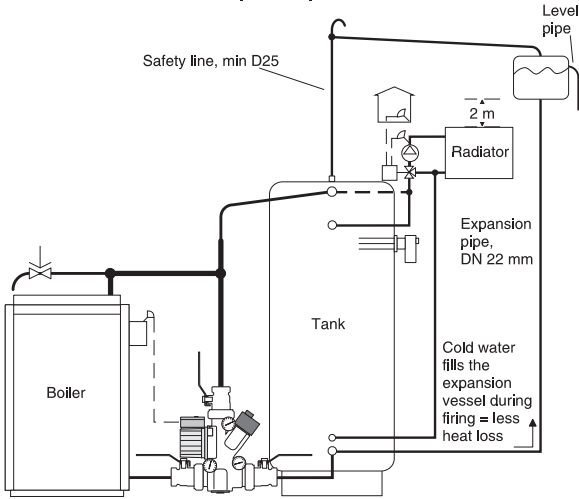

Connecting a pressurised expansion vessel

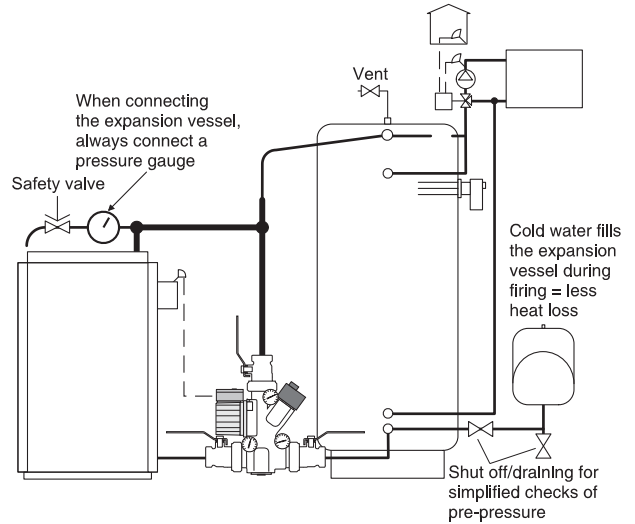

Alternative installation with open expansion vessel

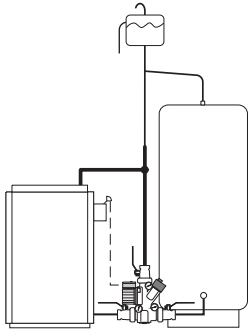

Bottom connection of the expansion vessel gives reduced heat losses.

NOTE See information on page 3 about the expansion vessel

Not recommended connections

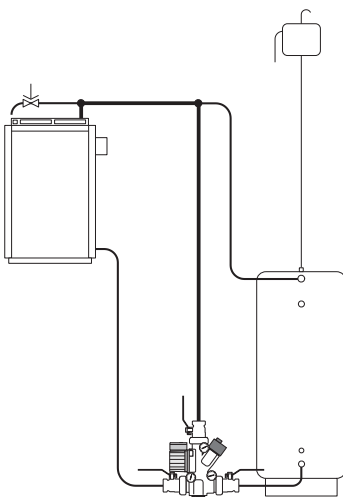

This type of installation will remove the self-circulation function. The check valve must be blocked to lower the risk of keeping the boiler warm. See picture 3 on next page for instruction.

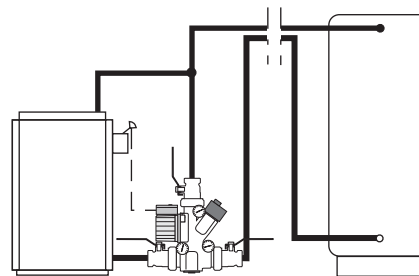

The pipe to the bottom of the tank must not be routed through the roof. This connection removes the self-circulation function.

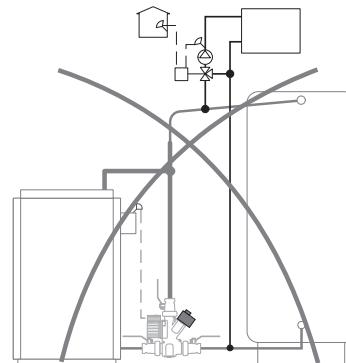

If the radiator is connected in this way there is a large risk of heat retention in the boiler and/or reduced heat to the radiator circuit.

Blocking the check valve

If you, for some reason, want to completely shut off the self circulation function, the check valve must be blocked. Use the blocking clip, placed at the bottom of the EPP-insulation (Picture 1), to block the check valve. The clip is then fastened around the check valve axis according to picture 3. To reach the axis, the spring needs to be removed.



Picture 1

The blocking clip is mounted here.

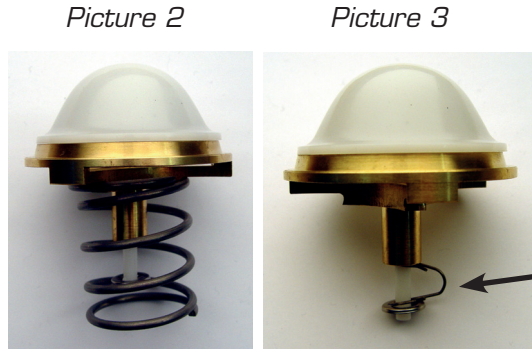

Picture 2

Picture 3

Blocking clip

Settings Thermomatic CC

Temperature is the only setting needed.

NOTE changes are not needed if default values (see table below) are correct for the installation. For installation of actuator and more advanced settings, see complete instruction included with Thermomatic CC.

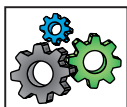
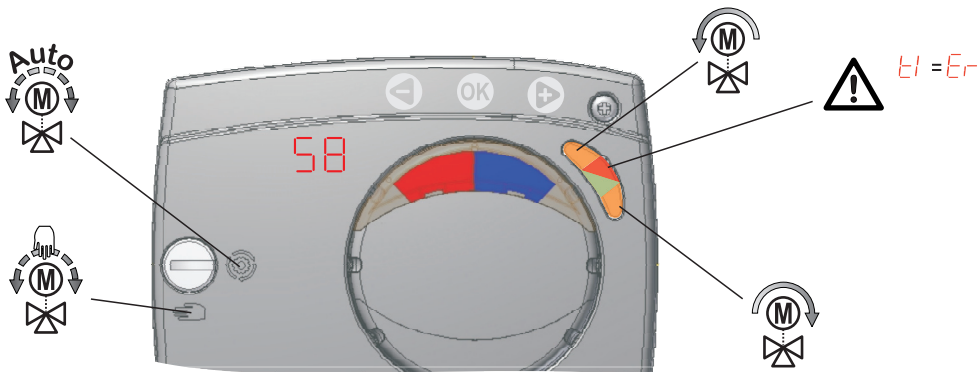

3 sec.
OK

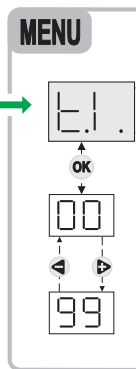

Parameter	Parameter description	Setting range	Default value
E1.	Setting of requested pipe temperature. Controller maintains this temperature by 3-point control of mixing valve.	0 ÷ 99 °C	60°C

Technical specifications

Power supply = 230 VAC, 50 Hz
 Power consumption = <1 VA
 Sensor = Pt1000 (1080 Ω 20 °C)
 Torque = 13 Nm
 Running angle = 2 min/90°
 Controller type = PID
 Software class = A
 Safety class = I
 Degree of protection = IP42
 Size (L x W x H) = 103 x 84 x 92 mm
 Storage temperature = -20 ÷ 65 °C
 Operation temperature = 0 ÷ 60 °C
 Humidity = 0 ÷ 80 % Rh, non condensing

Installation & setting pump Laddomatic M120

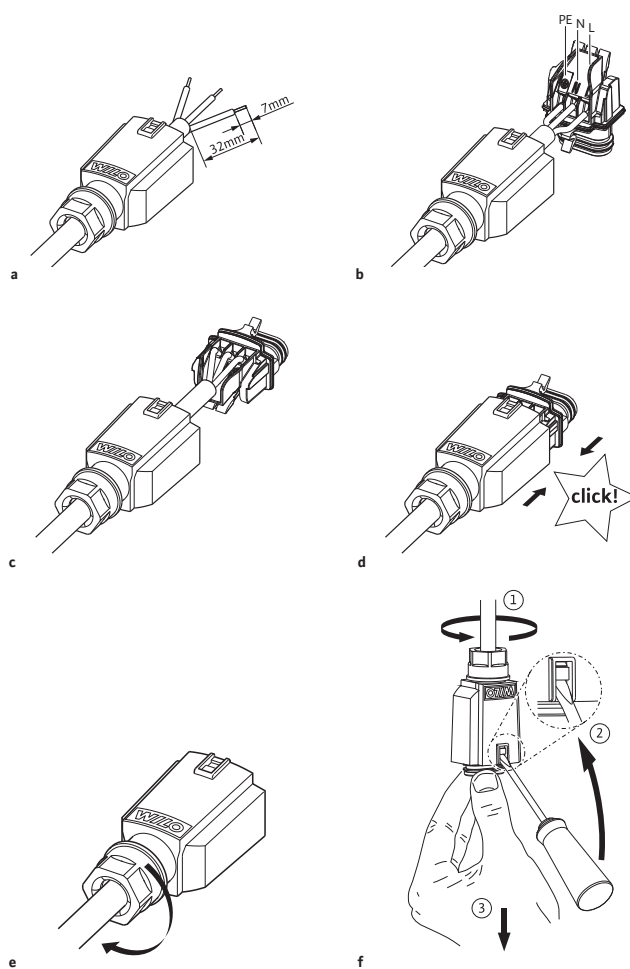
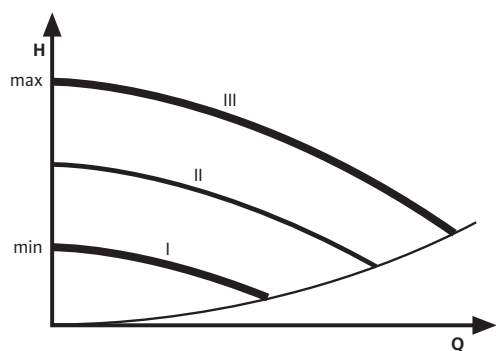
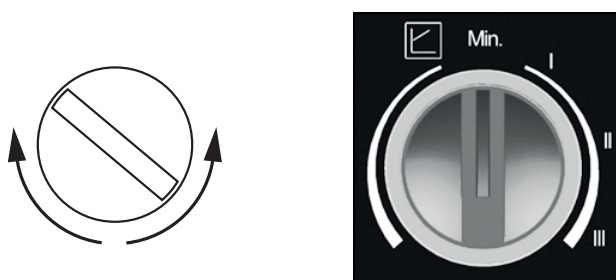

Wilo Yonos Para 7,5



4-75 W

230 V \pm 10 %, 50 Hz